

# A Case for Air Force Reorganization

Col Jeffrey P. Sundberg, USAF

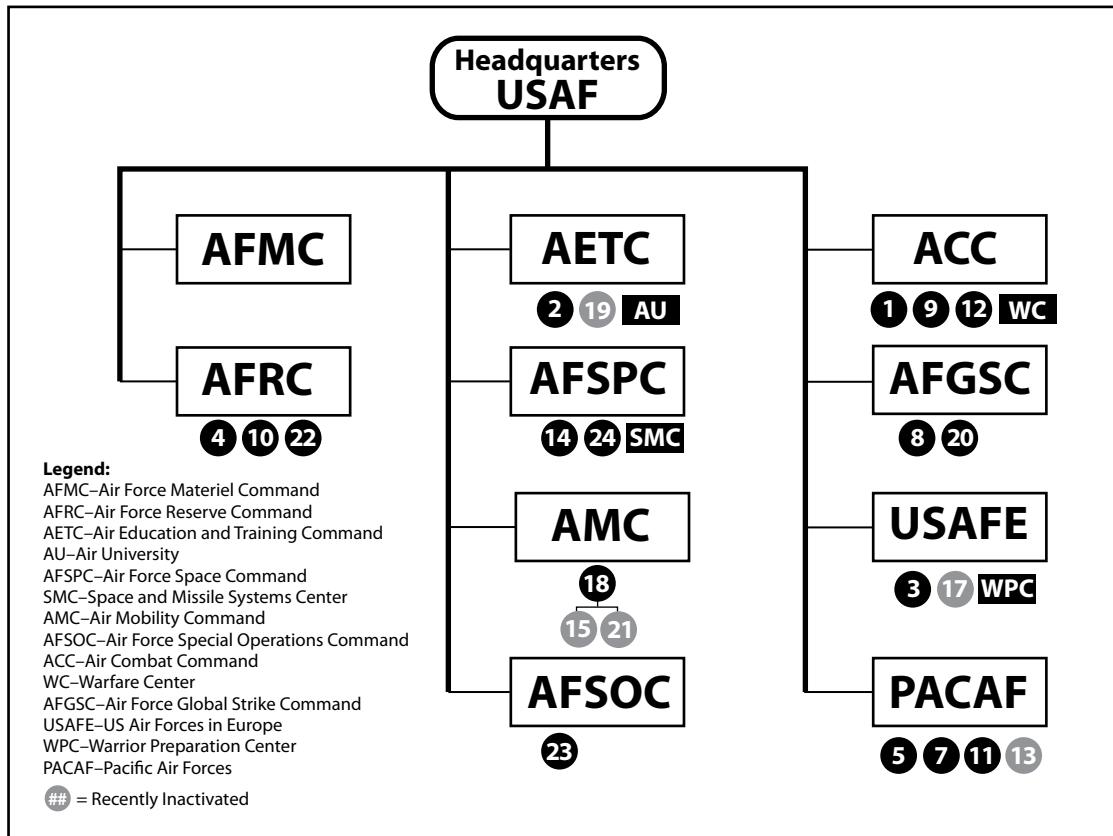


In light of the US Air Force's largest baseline budget decrease since 1994 and the most acute Department of Defense (DOD) budget decline since 1991 (with more cuts likely), financial pressures have forced the service to reduce costs and improve efficiencies in certain areas.<sup>1</sup> This article examines matters not often addressed in Air Staff money drills and capabilities assessments—specifically, it looks at the Air Force's top-level organizational structure, primarily targeting the organization and personnel categories of the doctrine, organization, training, materiel, leadership and education, personnel, and facilities (DOTMLPF) framework.

The argument presented here would remove a layer of the organization to flatten the structure, eliminating the major commands (MAJCOM) and increasing responsibilities of the Air Staff and numbered air forces (NAF). Given this new structure, the Air Staff would absorb a

large number of administrative functions currently held by the MAJCOMs. The NAFs would align regionally with combatant commands (COCOM), providing the crucial links to war-fighting commanders, and dedicate air staffs to handle regional conflicts and requirements. This proposed organization should improve support to COCOMs, advance Air Force regional expertise and focus through the NAFs, adapt more quickly to global situations, and ensure that the service's history and traditions endure. If these suggested recommendations improve organizational agility, increase combat capability, and reduce long-term costs, the Air Force could enhance operational effectiveness and save finite resources for other critical programs.

The National Security Act of 1947 created a separate Air Force with an initial organizational structure built from its Army roots. Over the next 65 years, the service morphed and expanded to its current structure (fig. 1). The primary mission of the Air Force and its responsibilities have changed little since 1947. Ultimately, the Air Staff prepares the service to fight the nation's wars; at such a time, forces are assigned to the appropriate COCOM to execute the mission. Today's Air Force consists of 10 MAJCOMs organized both geographically and functionally to carry out this title 10 mission.<sup>2</sup> In general the eight US-based MAJCOMs align functionally while the two overseas commands—US Air Forces in Europe and Pacific Air Forces—organize by geographic area. Except for Air Force Materiel Command (AFMC), every MAJCOM contains at least one NAF.



**Figure 1. Organizational structure of the Air Force.** (Data from “The Air Force in Facts and Figures: 2010 USAF Almanac,” *Air Force Magazine* 93, no. 5 [May 2010]: 36–66, [http://www.airforce-magazine.com/MagazineArchive/Magazine%20Documents/2010/May%202010/0510facts\\_figs.pdf](http://www.airforce-magazine.com/MagazineArchive/Magazine%20Documents/2010/May%202010/0510facts_figs.pdf). Circles represent NAFs subordinate to MAJCOMs, and rectangles depict major centers, except for all of AFMC’s.)

A total of 15 NAFs currently fall subordinate to nine MAJCOMs. Mostly found in AFMC, 16 centers also manage crucial Air Force functions. Subordinate to the NAFs and centers, 131 active duty and 34 reserve wings generate the basic combat units for employment. As of 2011, the Air Force consisted of 329,000 active duty personnel and more than 183,000 supporting civilians. The service flies approximately 4,600 active duty systems to train, test, and fight.<sup>3</sup> Given these

key organizational demographics, the following comprehensive analysis dissects the structure from several perspectives, identifies problems, discusses past reorganization efforts, outlines key tenets of the Air Force's structure, and proposes an organizational change as a solution for the future.

## Analysis of the Air Force's Organizational Structure

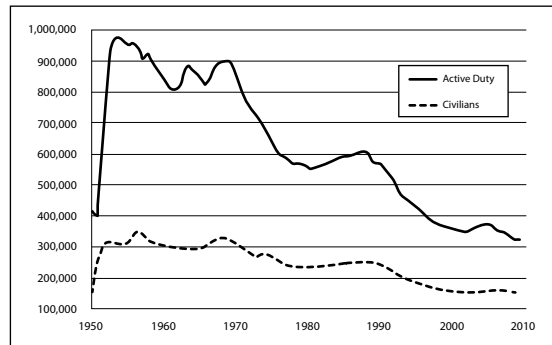
As mentioned above, the Air Force's initial organizational structure derived from the Army's but has since changed. In terms of sheer size and structure, alterations and the bureaucracy itself have created problems. We must assess the consequences of more than 65 years of organizational development and growth in light of current fiscal realities. Dramatic changes have occurred in the size of the force and the force structure over time. Based on personnel and force-structure analysis in relation to the organization, indicators suggest an overgrowth of staff officers and civilian personnel disproportionate to the decreasing size of the force and force structure.

### *Organizational Size*

Several factors have affected the Air Force's organizational size over the course of history. Technology and the acquisition of new weapons systems have been the principal drivers since the service's inception, and they continue in that role today. The nature of the threat, budgetary limitations, and wars also affect the growth or reduction of the Air Force.<sup>4</sup> In all categories, the Air Force of 2013 is vastly smaller than its predecessors. This examination of the organization over time assesses two key statistics: size of force and force structure. *Size of force* refers to the number of active duty Airmen or civilians in the service. It does not consider the contracting force—significant but difficult to measure—although the Defense Business Board observes that “there has also been an explosive growth in the number of DoD contractors.”<sup>5</sup> *Force structure* represents the machines that make up the Air Force's war-fighting capa-

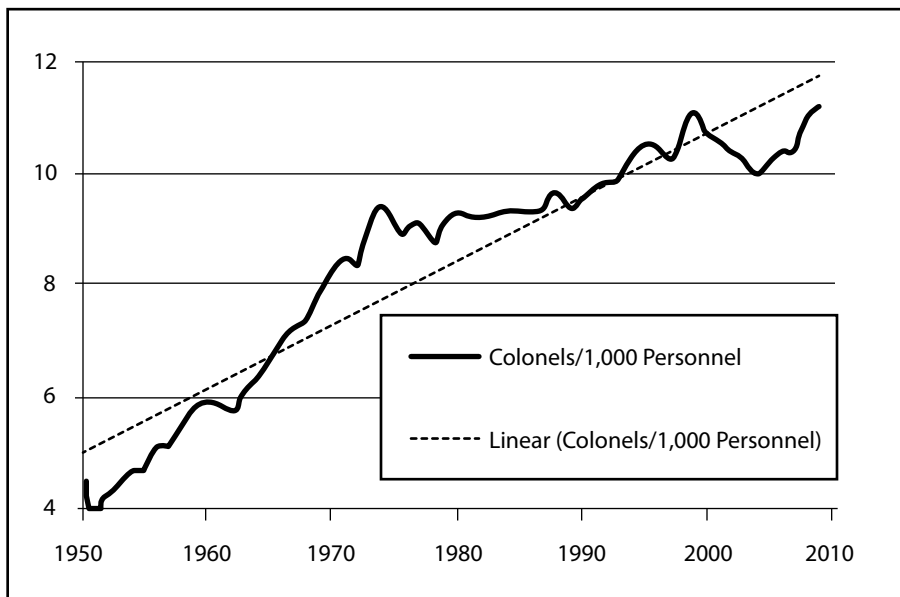
bilities, including training and testing systems, aircraft, nuclear missiles, and spacecraft operated by active duty personnel.

From 1947 to today, the size of force increased dramatically during the Korean War and then steadily declined, with spikes during the Vietnam War and prior to Operation Desert Storm (fig. 2). When the Air Force began as a separate service, it contained fewer than 350,000 Airmen in nearly 70 groups, considered wing equivalents. Near its Korean War peak in 1955, the service employed nearly 960,000 Airmen and 312,000 civilians.<sup>6</sup> In 2012 the active duty component employed only 329,000 Airmen and 183,000 civilian personnel.<sup>7</sup> Significant manpower changes over more than 65 years have prompted adjustments by the staff organizations as well. We first consider whether these staffs have grown proportionately and appropriately to support the size of force.

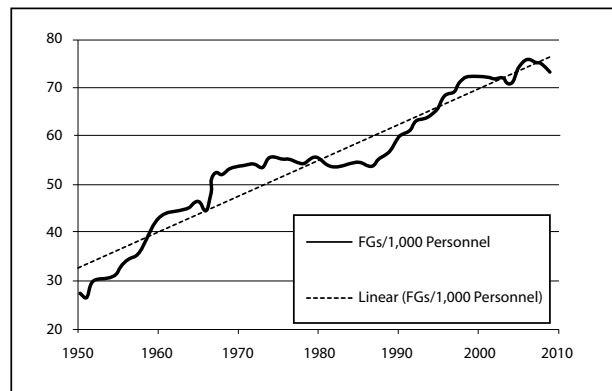


**Figure 2. Air Force active duty / civilian personnel totals by year.** (Data from “Air Force Strength from FY 1948–2012,” Air Force Personnel Center, accessed 9 January 2013, [http://access.afpc.af.mil/vbinDMZ/broker.exe?\\_program=DEMOGPUB.static\\_reports.sas&\\_service=pZ1pub1&\\_debug=0](http://access.afpc.af.mil/vbinDMZ/broker.exe?_program=DEMOGPUB.static_reports.sas&_service=pZ1pub1&_debug=0); and “DoD Employment by Organization and Function” [see FY 2002–FY 2009] and “DoD Civilian Strength—Fiscal Years 1950–2001” [see table], accessed 31 January 2011, <http://siadapp.dmdc.osd.mil/personnel/CIVILIAN/CIVTOP.HTM>.)

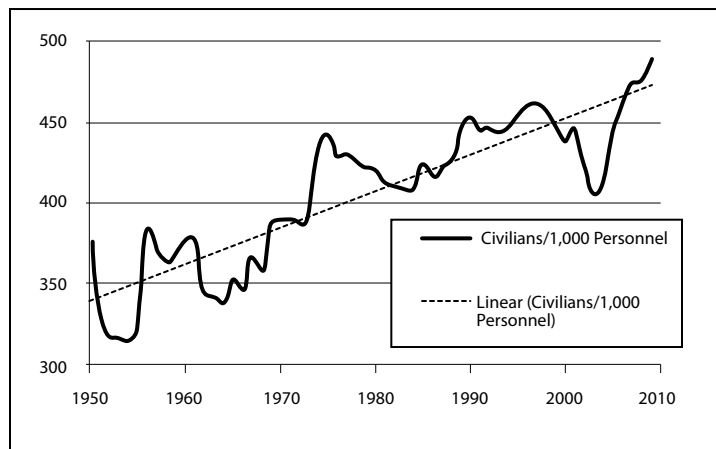
The number of field grade (FG) officers and civilian personnel offers an indication of and insight into the staff size in comparison to overall personnel strength. Staff organizations above wing level contain the majority of FG officers, including colonels, lieutenant colonels, and majors. The same holds true for civilian personnel. For our purposes, the FG category will include only lieutenant colonels and majors; a separate category represents colonels. Drawing on statistics from 1950 to 2009, the analysis uses a simple ratio to compare the number of each category with the total size of force. The results (figs. 3, 4, and 5) show clear trends indicating that the three categories unequivocally increase over time.



**Figure 3. Colonels per 1,000 Air Force personnel.** (Data from “Air Force Strength from FY 1948–2012,” Air Force Personnel Center, accessed 9 January 2013, [http://access.afpc.af.mil/vbinDMZ/broker.exe?\\_program=DEMOGPUB.static\\_reports.sas&\\_service=pZ1pub1&\\_debug=0](http://access.afpc.af.mil/vbinDMZ/broker.exe?_program=DEMOGPUB.static_reports.sas&_service=pZ1pub1&_debug=0).)



**Figure 4. FGs per 1,000 Air Force personnel.** (Data from “Air Force Strength from FY 1948–2012,” Air Force Personnel Center, accessed 9 January 2013, [http://access.afpc.af.mil/vbinDMZ/broker.exe?\\_program=DEMOGPUB.static\\_reports.sas&\\_service=pZ1pub1&\\_debug=0](http://access.afpc.af.mil/vbinDMZ/broker.exe?_program=DEMOGPUB.static_reports.sas&_service=pZ1pub1&_debug=0).)



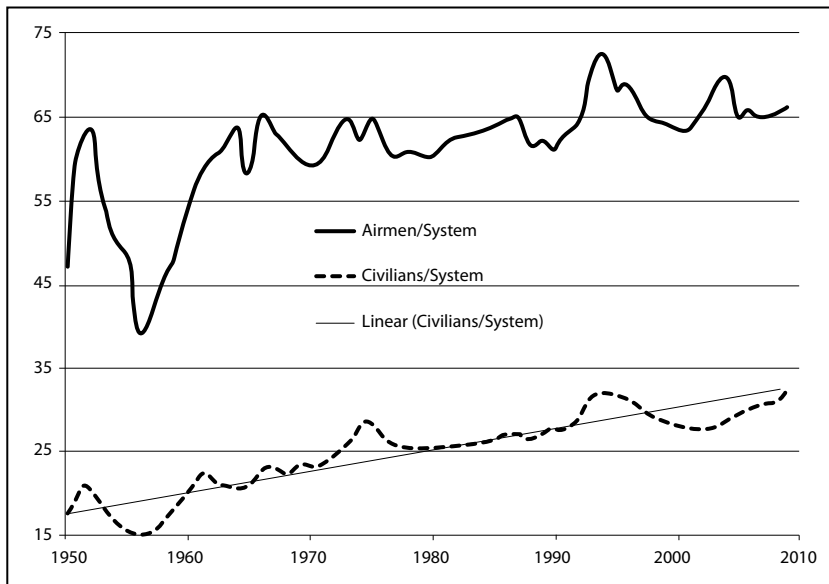
**Figure 5. Air Force civilians per 1,000 personnel.** (Data from “Air Force Strength from FY 1948–2012,” Air Force Personnel Center, accessed 9 January 2013, [http://access.afpc.af.mil/vbinDMZ/broker.exe?\\_program=DEMOGPUB.static\\_reports.sas&\\_service=pZ1pub1&\\_debug=0](http://access.afpc.af.mil/vbinDMZ/broker.exe?_program=DEMOGPUB.static_reports.sas&_service=pZ1pub1&_debug=0); and “DoD Employment by Organization and Function” [see FY 2002–FY 2009] and “DoD Civilian Strength—Fiscal Years 1950–2001” [see table], accessed 31 January 2011, <http://siadapp.dmdc.osd.mil/personnel/CIVILIAN/CIVTOP.HTM>.)

In other words, for every 1,000 personnel in 1950, the Air Force employed 4.5 colonels, 28 FGs, and 376 civilians. By 1980 the officer numbers had essentially doubled to 9.3 colonels and 56 FGs, while the civilian number increased to 421. By 2009 the numbers had grown further still: 11 colonels, 74 FGs, and 488 civilians per 1,000 Airmen. General officers (not addressed here due to limited data) appear to follow identical trend lines over the same period. Since 1975 the number of Air Force general officers has declined by 17 percent, and both the size of force and force structure have decreased more rapidly (47 percent).<sup>8</sup> These statistics indicate that the organization is growing appreciably more top heavy, suggesting that the requirement for staff positions has increased steadily. If that is not the case, then the Air Force's staff has grown disproportionately. One explanation would indicate that, as with any organization, the Air Force incurs an overhead cost for management and that these staff levels could represent the minimum necessary for operating. If, however, an overstaffing problem exists, several theories lend insight into why and how this overgrowth occurs. Noted German sociologist Max Weber discusses several reasons for overgrowth of staff positions and the challenge of organizational changes, articulating the fundamental truism that "once established and having fulfilled its task, an office tends to continue in existence and be held by another incumbent."<sup>9</sup> Consequently, organizational offices will perpetuate, often well past usefulness, until forcible alteration or catastrophic failure.

Force structure levels provide another organizational insight to consider. Again, force structure includes all systems in the active duty Air Force's inventory. This approach analyzes how staff presence, as indicated by levels of higher-ranking officers and civilians, varies over time as a function of force structure. Again, the colonel, FG, and civilian categories encompass the measures analyzed. First, however, the total number of personnel per system offers some measure of assessment. Except for significant fluctuations during and after the Korean War, the total personnel-to-system ratio stabilizes at about 65 Airmen (fig. 6). Therefore, the Air Force has maintained a directly proportional



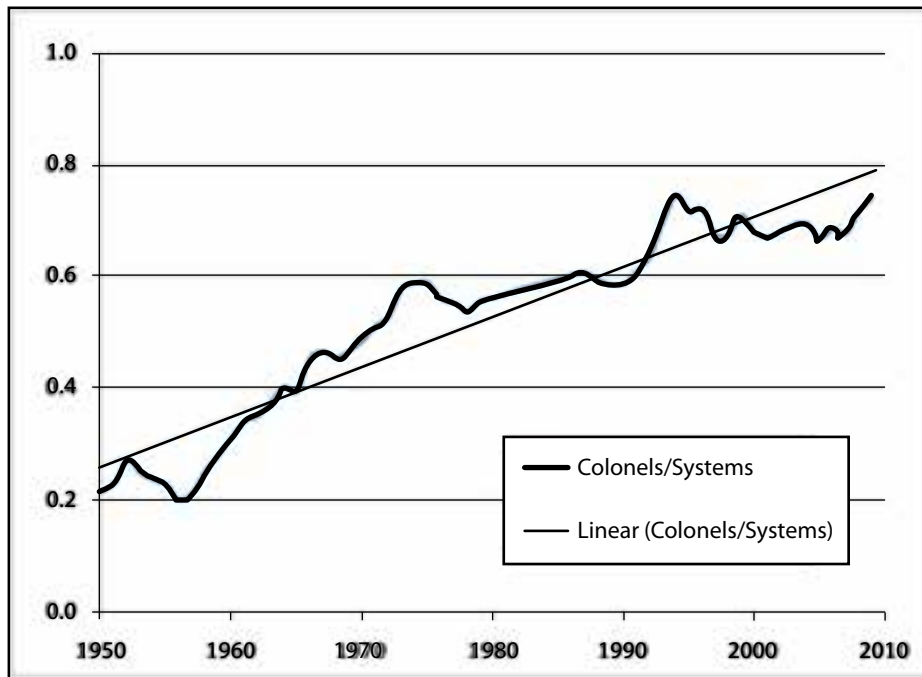
relationship between the number of systems and total strength of active duty personnel. One may attribute the minor increase to the fact that increasingly technological systems require more personnel for operations, information processing, and maintenance.



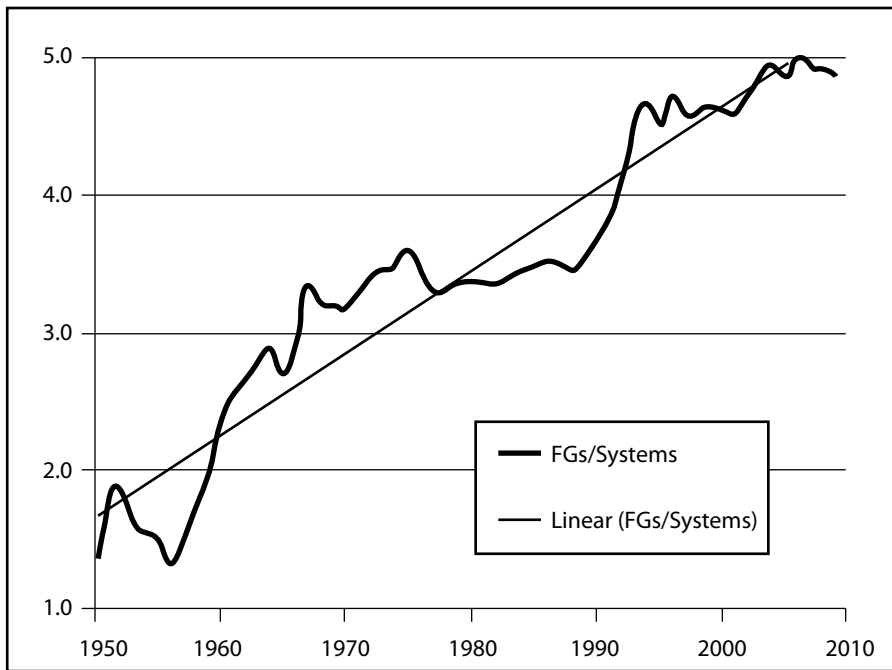
**Figure 6. Total active duty Airmen and civilians per Air Force system.** (Data from “Air Force Strength from FY 1948–2012,” Air Force Personnel Center, accessed 9 January 2013, [http://access.afpc.af.mil/vbinDMZ/broker.exe?\\_program=DEMOGPUB.static\\_reports.sas&\\_service=pZ1pub1&\\_debug=0](http://access.afpc.af.mil/vbinDMZ/broker.exe?_program=DEMOGPUB.static_reports.sas&_service=pZ1pub1&_debug=0); “DoD Employment by Organization and Function” [see FY 2002–FY 2009] and “DoD Civilian Strength—Fiscal Years 1950–2001” [see table], accessed 31 January 2011, <http://siadapp.dmdc.osd.mil/personnel/CIVILIAN/CIVTOP.HTM>; and James C. Ruehrmund Jr. and Christopher J. Bowie, *Arsenal of Airpower: USAF Aircraft Inventory, 1950–2009* [Washington, DC: Mitchell Institute Press, 2010], 15–26, [http://www.afa.org/mitchell/reports/MS\\_TAI\\_1110.pdf](http://www.afa.org/mitchell/reports/MS_TAI_1110.pdf).)

All other categories show a different, increasing trend over time. In the 1960s, the civilian force stayed steady around 18 civilians per Air Force system. After peaking temporarily at 34 civilians per system in

the mid-1990s, the ratio dropped but eventually returned to this level in 2009.<sup>10</sup> For the rank of colonel, the measure rises steadily since a low of 0.2 colonels per system in 1957 (fig. 7). By 1980 the colonel ratio had risen above 0.5 per system. Although the numbers trended downward prior to 2005, this ratio reached the highest level in 2009 at 0.7 colonels for every Air Force system. The FGs follow a nearly identical path (fig. 8). In 1957 the ratio reached a low of 1.4 FGs per system, leveled off for several decades, and then climbed constantly until it reached the current level of 5.0 FGs per Air Force system.



**Figure 7. Colonels per Air Force system.** (Data from “Air Force Strength from FY 1948–2012,” Air Force Personnel Center, accessed 9 January 2013, [http://access.afpc.af.mil/vbinDMZ/broker.exe?\\_program=DEMOGPUB.static\\_reports.sas&\\_service=pZ1pub1&\\_debug=0](http://access.afpc.af.mil/vbinDMZ/broker.exe?_program=DEMOGPUB.static_reports.sas&_service=pZ1pub1&_debug=0); and James C. Ruehrmund Jr. and Christopher J. Bowie, *Arsenal of Airpower: USAF Aircraft Inventory, 1950–2009* [Washington, DC: Mitchell Institute Press, 2010], 15–26, [http://www.afa.org/mitchell/reports/MS\\_TAI\\_1110.pdf](http://www.afa.org/mitchell/reports/MS_TAI_1110.pdf).)



**Figure 8. FGs per Air Force system.** (Data from “Air Force Strength from FY 1948–2012,” Air Force Personnel Center, accessed 9 January 2013, [http://access.afpc.af.mil/vbinDMZ/broker.exe?\\_program=DEMOGPUB.static\\_reports.sas&\\_service=pZ1pub1&\\_debug=0](http://access.afpc.af.mil/vbinDMZ/broker.exe?_program=DEMOGPUB.static_reports.sas&_service=pZ1pub1&_debug=0); and James C. Ruehrmund Jr. and Christopher J. Bowie, *Arsenal of Airpower: USAF Aircraft Inventory, 1950–2009* [Washington, DC: Mitchell Institute Press, 2010], 15–26, [http://www.afa.org/mitchell/reports/MS\\_TAI\\_1110.pdf](http://www.afa.org/mitchell/reports/MS_TAI_1110.pdf).)

No clear reasons exist for the increasing ratios, other than those suggested earlier for size of force. Although high-technology systems can substantiate slight gains for civilians and possibly necessitate more staff management, such factors alone cannot justify these notable trends. Neither do other possibilities—including the diversity and different types of systems, as well as operating requirements—offer a good reason for these increases. More apparently, these trends indicate overbureaucratic tendencies, as predicted by Weber and others.

The numbers speak quite clearly: the substantial growth in the number of FGs and civilians, compared to both size of force and force structure, suggests an organization overflowing with staff personnel. Most staff organizations, such as NAFs and MAJCOMs, would suggest that they have inadequate manpower, but the problem points to the possibility that too many such organizations spread the available manpower too thinly.<sup>11</sup> To address these trends, we must direct our attention to the Air Force's organizational hierarchy, looking for areas that lend themselves to reductions.

The second examination of the Air Force's organization explores its width, depth, and functionality. Specifically, width refers to the numbers of subordinate units per unit of command or how flat the structure appears. A flat organization would have several subunits one level below. Depth denotes the distance from the top of the hierarchy to the bottom. This discussion explores the depth down to wing level. However, regarding the full organizational depth, one must remember that the typical Airman in a flight works at least four levels below the wing.<sup>12</sup> Hence, multiple command and staff levels still remain at and below the wing. Lastly, the issue of functional commands builds upon these width and depth issues and evaluates the current functional nature of MAJCOMs.

### *Organizational Width and Depth*

The width of an organization, also commonly referred to as span of control, describes the number of major subordinates under a single command. For Headquarters Air Force, 10 MAJCOMs represent the width, each one having a different width, varying from AFMC with 11 centers to Air Force Special Operations Command with one NAF. Excluding AFMC, MAJCOMs have one to four subordinate NAFs and centers. The number of wings subordinate to NAFs varies even more. Although Eighteenth Air Force has 14 wings or group-equivalent organizations, most NAFs have either two or three subordinate wings. The vast difference in the NAF wing allotment may suggest poor dis-

tribution and broad variations in spans of control for each NAF commander.

The varying distribution of subordinate units for the top three layers suggests that some have an overextended span of control while others remain underutilized.<sup>13</sup> Superficially, it seems that opportunities exist for adjusting organizational width. However, as a prominent expert in business management cautions, flattening an organization not only should create efficiencies by stretching leaders to the extreme but also should promote in concert “democratic participation, greater efficiency, and substantially improved organizational morale.”<sup>14</sup> These warnings deserve ample consideration in any reorganization designed to alter width, just as the width issues highlight areas that may prove fruitful in discussions about reorganization.

Inextricably connected to the issue of organizational width, the depth of a hierarchical structure generates additional issues. The Air Force created its organizational depth to manage span of control, align functions, and overcome issues of distance generated by the global positioning of air forces. The depth of the Air Force organization, from the top to wing level, consists of the four levels discussed previously. Therefore, the full organizational depth, down to the Airman, includes eight levels from top to bottom, which—though typical and prevalent—do not cover every situation within the structure. More importantly, this depth has remained steady for nearly 29 years.

During reorganizational efforts of the early 1990s, which affected both width and depth, the Air Force completely eliminated the air-division level between NAFs and wings, thereby reducing the organization from nine to eight levels. This reduction of depth—the only one in the service’s history—happened at a time when the size of force had diminished by 50 percent over a 24-year period.<sup>15</sup> Thus, the Air Force returned to the same eight-level organizational depth established for the 1943 Army Air Forces, which boasted 2,400,000 Airmen and nearly 80,000 aircraft at its peak.<sup>16</sup> As of 2011, just two decades after removal

of the air division, the size of force has shrunk another 30 percent, yet the same eight-level organization persists.

As is the case with width, excessive depth can create challenges for any organizational structure. For the Air Force, communications and redundancies offer two excellent examples. Prior to the age of computers, information flowed slowly, and certain types of coordination and communication were impossible over the great distances involved. Today, no limitations exist for information flowing throughout the organization. In his book *Control without Bureaucracy*, David Mitchell talks about problems with information flowing up and down an organization, noting that excessive organizational depth adversely affects the management of today's volume of information. In fact, Mitchell says that depth of the hierarchy "acts as a powerful amplifier," essentially creating an overload of information to manage.<sup>17</sup> Practically, this is a prominent issue, given every level's need to stay informed and the overwhelming flow of reporting, correspondence, and e-mail moving into the upper echelons.

In light of the information overflow and deep hierarchy, Mitchell also points out that good ideas tend to get filtered or lost in the noise.<sup>18</sup> Therefore, the depth of the Air Force's hierarchical organization may not allow those great ideas to flow easily from the field to the Air Staff. He also argues that the filtering effect makes it difficult for leaders to control operations strategically because condensed and summarized information does not build adequate situational awareness for educated decision making.<sup>19</sup>

Excessive redundancies may also develop, based on the organizational depth. Each level demands a certain degree of administration and redundant functions—some necessary but others wasteful and candidates for elimination. For example, every MAJCOM has a command supplement instruction to the 99-page Air Force Instruction 10-207, *Command Posts*, 1 February 2012. Air Combat Command's (ACC) supplement adds another 153 pages of instructions, Air Force Space Command's (AFSPC) 136 pages, and so on. With the service having only 73

major installations worldwide, this function could be standardized at a higher level to avoid the extra effort of creating and administering these MAJCOM-level instructions. This example is one of many since each MAJCOM produces hundreds of supplements and command instructions. Certainly, every organization has hierarchical depth and some level of duplication; however, elimination of unnecessary redundancies could generate tangible efficiencies and simplify operations.

### *A Functional Organization*

The functional nature of MAJCOMs can further exacerbate the redundancies in different command chains created by depth. Eight US-based MAJCOMs organize functionally. A number of organizational theories address this type of functional structure, and several identify potential problems found within the Air Force organization. In particular, problems associated with functional “rice bowls” and “tribes” illustrate these issues.

Although seemingly logical and possibly easier to manage, delegating missions and responsibilities in a functional organization can present difficulties. First, the development of functional rice bowls becomes one of the most apparent issues.<sup>20</sup> Given a problem and the need to develop a capability, AFSPC will most certainly answer with a space solution while ACC will develop an aircraft-based option. American political scientist Samuel Huntington identifies this issue clearly in terms of the soldier: “He tends to stress those military needs and forces with which he is particularly familiar. To the extent that he acts in this manner he becomes a spokesman for a particular service or branch interest rather than for the military viewpoint as a whole.”<sup>21</sup> Because functional commands include expert operators grown from within the command, an unhealthy competition develops among functional commands to secure limited resources, much like the competition among the different US military services.

Weber also predicts this problem with functional organizations, noting “the tendency of officials to treat their official function from what

is substantively a utilitarian point of view in the interest of the welfare of those under their authority.”<sup>22</sup> In the Air Force, the functional MAJCOMs tend to breed and perpetuate elite corps of individuals. Maj William Thomas echoes this issue, warning about the creation of “subcultures” or “tribes” and reiterating Huntington’s concerns: “The Air Force may experience difficulties in achieving goals because members of subcultures do not remain focused on the overall goals of the organization, emphasizing instead the advancement of their specialty or of themselves.”<sup>23</sup>

The attempt to develop a long-range-strike (LRS) capability offers a good example of what can happen within a functional structure.<sup>24</sup> Similar capability efforts considered part of this initiative include prompt global strike, the next-generation bomber, the hypersonic cruise vehicle, and the LRS system. Each of these programs, often driven by different MAJCOMs or the Air Staff, entails extraordinary exertion and tremendous amounts of funding. As the requirements process begins for the MAJCOMs, resident tribal experts in each command would certainly suggest a solution with which they are familiar. ACC would develop and submit aircraft-based solutions to the Air Staff, while AFSPC would present conventional missile system capabilities.<sup>25</sup> A MAJCOM would not only present but also champion the concept for selection and funding even though the solution may not be in the best interest of the Air Force organization or even the United States. One could argue that these functional approaches have kept the service working on developing an LRS capability development for the past 10 years yet coming no closer to a fielded solution. The presence of these rice bowls and tribes throughout the organization forces one to question whether a functional division can ensure that the Air Force reaches the overarching organizational goals in the most effective and efficient manner, given the current and anticipated global environment.



## Possible Organizational Changes to the Air Force

This article now explores possibilities for changing the Air Force's current structure. After addressing recent organizational changes and historical tenets of the service, it proposes fundamental alterations that would eliminate organizational depth and consider functional challenges. Again, any attempt at reorganization must ensure no loss in the Air Force's ability to execute its mission, must improve support to global COCOMs, and must generate tangible efficiencies.

### *Recent Reorganizational Efforts and Official Guidance*

*The U.S. Air Force Transformation Flight Plan 2004* speaks of transforming the Air Force organization, proposing the use of “transformational organizational arrangements” to better carry out the mission.<sup>26</sup> One construct instituted from this wave of transformation included the war-fighting headquarters concept to support combatant commanders. These headquarters would serve as the Air Force's single voice to the combatant commander and unify air forces to accomplish the mission. Thus, each new war-fighting headquarters staff consisted of a small core of personnel to support the specific combatant commander. Although the flight plan proposed major organizational renovation, the small changes and redirections that occurred did not produce the desired transformation goals.

The *2008 Air Force Strategic Plan* continues these themes, identifying one of five priorities to “Modernize Our Air and Space . . . Organizations” and setting a specific goal to “Align Organization and Processes with Air Force Core Functions and DoD Core Competencies.”<sup>27</sup> No concrete evidence suggests that changes took place as a result of this strategic plan. Though not directly linked to these strategic goals, another effort to manage the organization emerged in 2009 as the Air Force chief of staff directed unit manning minimums in the Organizational Threshold Review. Emphasizing the wing level and below, the review forced smaller units to merge and reorganize to meet these requirements.<sup>28</sup> It attempted to reorganize and consolidate units but did not

address larger Air Force structural problems whose solution would allow it to become a more effective organization, as identified in the strategic plan, mentioned above. Moreover, in 2011 the Air Force budget director announced a reorganizational proposal to consolidate four air and space operations centers and, more importantly, three NAFs.<sup>29</sup> All of these documents and efforts demonstrate concern about re-vamping the service's organization but fail to address the core issues highlighted earlier. If anything, recent actions suggest that the Air Force believes that adding new organizations (e.g., Air Force Global Strike Command and Twenty-Fourth Air Force) can fix problems. Rather than meet transformational objectives, these additions increase staff requirements, putting more strain on the shrinking size of force. Such inconsistent actions do not follow any common strategic theme, which should exist in published guidance.

Several key Air Force documents deal with the organizational structure: Air Force Doctrine Document (AFDD) 2, *Operations and Organization*, 3 April 2007; Air Force Pamphlet (AFPAM) 38-102, *Headquarters United States Air Force Organization and Functions*, 1 January 2004; Air Force Instruction (AFI) 38-101, *Air Force Organization*, 16 March 2011; and Air Force Policy Directive (AFPD) 38-1, *Organization and Unit Designations*, 24 August 2011. For the most part, AFDD 2 builds upon basic Air Force doctrine by expanding on the commanding and organizing of air and space forces, including key roles and responsibilities. AFPAM 38-102, although dated 2004, supplies details about the basic Air Staff organization and functions. Both of these documents, as well as AFI 38-101, provide thorough background information and specific requirements concerning the service's current organizational structure.

Further adding to these requirements, AFI 38-101 includes guidance regarding how the organization should structure itself, laying out four organizational principles: emphasis on wartime tasks, functional grouping, lean organizational structures, and a skip-echelon structure. Emphasis on wartime tasks should remain at the forefront of all organizational designs. (This article addressed functional grouping earlier,

and the need for a skip-echelon structure suggests an organization with excess depth.) The discussion of lean organizational structure highlights the need for a flatter makeup with minimal layers:

Organizations must encourage rapid decision making, so they should be flat structures without intermediate levels, unless mission requirements cannot otherwise be met. . . . Organizational levels that exist only to review and transmit information or tasking should be eliminated. Both the number of supervisors and the number of internal subdivisions within organizations should be designed to minimize layers and maximize worker-to-supervisor ratios.<sup>30</sup>

Further, AFPD 38-1 outlines more organizational principles (examined in the following section) that build upon those in AFI 38-101. Overall, even though some guidance exists for the organizational structure, the Air Force maintains the freedom to design and develop an organization to meet the mission. Before discussing organizational change, one must understand and preserve the service's culture and traditions when possible.

### ***Organizational Tenets: Maintaining Air Force Traditions/Principles***

Over the history of aviation forces in the US military, different principles for the new and evolved organizations rang true for leaders. In the early years, the War Department directed several of these Air Force organizational themes that resonate from the service's history. Any future organizational changes must maintain these principles in order to capture important historical lessons and cultural traditions. The principles and historical tenets directed by the War Department have shaped the Air Force organization of today. In accordance with AFPD 38-1, the service continues to restate a number of them (see table below). Along with the characteristics currently identified in Air Force directives, they represent a solid foundation on which to base future organizational changes.

**Table. Historical and modern organizational principles of the Air Force**

<i>Historical Organizational Principles</i>	<i>Modern Organizational Principles</i>
Concentration of Airpower	Mission Orientation
Unity of Command	Unambiguous Command
Decentralization	Decentralization
Simplicity	Simplicity
Flexibility	Flexibility
Research and Development / Intelligence	Agility
Joint Coordination	Standardization

Source: AFPD 38-1, *Organization and Unit Designations*, 24 August 2011, 2, <http://www.e-publishing.af.mil/shared/media/epubs/AFPD38-1.pdf>; and Circular no. 138, *War Department Reorganization*, 14 May 1946, 3.

### *Reorganization Proposal*

If the Air Force considers a radical reorganization, the challenges and principles highlighted earlier suggest a few approaches, the first of which would decrease organizational depth. Assuming that the Air Staff and wings remain, eliminating a layer would necessitate removal of either MAJCOMs or NAFs. The second would reduce organizational width by combining units. As seen in the Organizational Threshold Review of 2009 and recent efficiency measures taken by the Air Force, this option constitutes the “main effort” to date in reorganization. Lastly, a combination of consolidation and elimination of width and depth, although a more aggressive approach, could bring about more synergistic organizational effects and greater efficiencies.

The suggestion discussed hereafter utilizes the third approach by removing the MAJCOM level while also consolidating certain functions and units. This new organization still contains functional commands, but most of them directly support specified COCOMs. Nevertheless, a conceptual model of this proposed organization primarily takes on a regional focus along COCOM lines (fig. 9), resulting in a much flatter organization with 13 NAFs, AFMC, and Air Force Reserve Command reporting directly to Headquarters Air Force. The following clarifies a few points of liberal consolidation: Second Air Force replaces Air Edu-

cation and Training Command. In Europe, Eighth Air Force would replace US Air Forces in Europe and absorb Third Air Force. Thirteenth Air Force replaces Pacific Air Forces and gains Fifth Air Force, while First Air Force absorbs Eleventh Air Force. Given an active Korean theater, maintaining Seventh Air Force seems a logical choice and an example of creating additional NAFs to support specific missions and command structures.

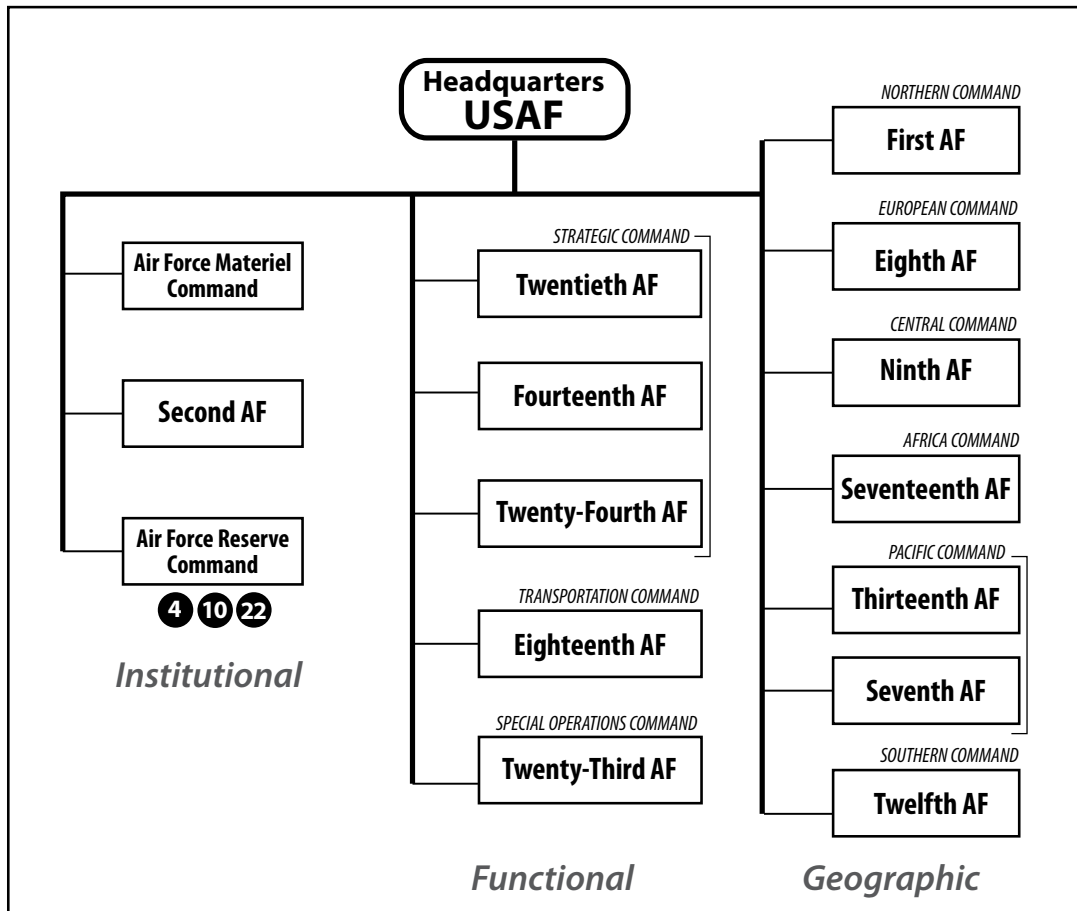


Figure 9. Proposed Air Force reorganization

The motivation to keep NAFs rather than MAJCOMs proceeds from four factors, based principally on the need to focus the organization geographically. First, with the elimination of one layer, the strategy should emphasize the primary customer—COCOMs. A geographical split of the organization makes sense in terms of orienting the organization globally and improving the capability to support COCOMs. Several sources, including title 10 and the *Unified Command Plan* of 2011, point to the benefits of a command and control relationship with forces assigned geographically: “Except as otherwise directed . . . all forces operating within the geographic area of responsibility assigned to a combatant command . . . will be assigned or attached to and under the command of that commander.”<sup>31</sup> Carl Builder, a former RAND military expert, also identified this strategy in an article about the need to shift the Air Force organization regionally toward the COCOMs, thereby better preparing the service for future crises and conflicts.<sup>32</sup>

Adding more justification, this type of structure—by dedicating NAFs assigned to COCOMs—automatically creates a commander of Air Force forces and a joint force air component commander standing in place with committed air and space operations centers to execute operations in accordance with Air Force doctrine.<sup>33</sup> Essentially, this situation exists today, but the arrangement would solidify and simplify the command and control function. Given a more robust staff, each NAF should also have adequate manpower to manage the full spectrum of doctrinal duties without augmentation, as is often required today. Additionally, NAF staffs would also manage some level of responsibility for organizing, training, and equipping.

The second factor should ensure that the Air Force structure can rapidly adapt and flex to meet the changing, complex global environment. One of two conclusions of 2010’s *Quadrennial Defense Review Report* identifies this requirement: “The second theme to emerge from [the review’s] analyses is the importance of ensuring that U.S. forces are flexible and adaptable so that they can confront the full range of challenges that could emerge from a complex and dynamic security

environment.”<sup>34</sup> A seemingly obvious statement for operational forces, this should also apply to the staff functions and organizations. Implementing a more streamlined organization and having the NAFs report directly to Headquarters Air Force should allow the Air Staff to better coordinate and deconflict these issues more quickly and address Air Force requirements across the entire globe.

Also emphasized in the *National Security Strategy*, *National Military Strategy of the United States of America*, and *Quadrennial Defense Review Report* of 2010, one of the key military missions concerns theater security cooperation—the third factor. These three strategic guiding documents stress the need to strengthen international security, build the capacities of partner states, and promote peace through international order.<sup>35</sup> More specifically, the chairman of the Joint Chiefs of Staff directs responsibilities for all forces and COCOMs: “The Joint Force, Combatant Commanders, and Service Chiefs shall actively partner with other U.S. Government agencies to pursue theater security cooperation to increase collective security skills with a wider range of partners.”<sup>36</sup> Without a doubt, a regionally focused organization must develop to meet these key strategic needs—an organization that can better cultivate a staff with the necessary cultural and area expertise.

The fourth factor needs little explanation since maintaining tradition and culture should pervade any reorganizational effort. As highlighted earlier, cultural principles and history should remain prevalent and carry on the Air Force’s traditions. For instance, the tremendous accomplishments and rich history of Eighth Air Force, exemplified in the European theater during World War II, can carry on as part of a dedicated NAF to US European Command.

Eliminating a layer in the organization should produce benefits for the Air Force. Where possible, devolving functions from MAJCOMs to NAFs (and avoiding duplication in the process) will permit decentralized execution for direct support of key customers—the COCOMs. Additionally, removal of an entire level will free those staff positions to bolster Headquarters Air Force as well as the NAFs and wings, allow

the elimination of significant staff manpower, and generate savings. To realize measurable savings, the Air Force should initiate a substantial overall reduction in staff manpower rather than play a shell game that simply moves manpower around to new locations. Increasing the size of staffs at the remaining top three levels (a necessity, given additional organizational responsibilities) may necessitate a more robust general staff model to redesign the Air Staff.

The Air Force chief of staff needs a larger staff, especially in light of a greater span of control and flatter organizational hierarchy, to work the vast issues that do not demand intimate commander involvement and to control cross-coordination efforts. Therefore, should reorganization do away with one level of the hierarchy, the service must add personnel to Headquarters Air Force and develop the appropriate staff structure with professionals, both military and civilians, in order to properly support the new Air Force organization.

## Conclusions

Today's Air Force finds its force structure and manning at all-time lows, yet staffing positions have increased disproportionately over the past 60 years. To reverse this trend, reduce organization depth, move away from functional commands, simplify the structure, and create necessary efficiencies, the Air Force should consider removing the MAJCOMs and promoting the NAFs subordinate to Headquarters Air Force. A primarily geographic restructuring will permit the service to best support the most important customers—the combatant commanders. Additionally, regionally focused NAFs will improve theater security and adapt more quickly to complex global conflicts and conditions.

The Air Force must fund critical capabilities and programs, yet it faces a number of budgetary pressures, both external and internal. The difficult task of finding effective strategies to create the necessary efficiencies demands genuine institutional introspection. Given its current composition, the service must consider a reorganization strategy



for the top-level structure that will cut the bureaucracy and create a more efficient, adaptive, and effective organization. The Air Force should wholeheartedly consider reorganization by eliminating the MAJCOMs, thereby elevating the NAFs and becoming more geographically oriented and better suited to support the US COCOMs. Ultimately, reorganization should generate the considerable financial savings needed in today's constrained environment and maintain the critical airpower principles and traditions for a more effective war-fighting Air Force. ★

---

## Notes

1. "The Air Force in Facts and Figures: 2010 USAF Almanac," *Air Force Magazine* 93, no. 5 (May 2010): 56, [http://www.airforce-magazine.com/MagazineArchive/Magazine%20Documents/2010/May%202010/0510facts\\_figs.pdf](http://www.airforce-magazine.com/MagazineArchive/Magazine%20Documents/2010/May%202010/0510facts_figs.pdf); and "USAF Almanac: The Air Force in Facts and Figures," *Air Force Magazine* 83, no. 5 (May 2000): 58, [http://www.airforce-magazine.com/MagazineArchive/Magazine%20Documents/2000/May%202000/0500facts\\_figs.pdf](http://www.airforce-magazine.com/MagazineArchive/Magazine%20Documents/2000/May%202000/0500facts_figs.pdf). Measured in constant dollars, the Air Force's baseline budget declined in 2010 by 5.22 percent from the previous year. It declined by 7.52 percent in 1994. The DOD's projected budget for 2011, also measured in constant dollars, will decrease by 8.85 percent. The last DOD budget decrease greater than this (12.8 percent) occurred in 1991. Office of Management and Budget, *Historical Tables: Budget of the U.S. Government, Fiscal Year 2010* (Washington, DC: Office of Management and Budget, 2009), 123–26, <http://www.gpo.gov/fdsys/pkg/BUDGET-2010-TAB/pdf/BUDGET-2010-TAB.pdf>.

2. *United States Code*, Title 10: Armed Forces. Title 10 of the *United States Code* provides the legal basis for the roles, missions, and organization for the DOD and each of the armed services.

3. *Ibid.*, 60–62. In 2010 the Air Force maintained just over 4,000 aircraft in the active duty inventory and another 1,500 with the Air National Guard and Air Force Reserve units. Intercontinental ballistic missiles stand at 450 systems, and 52 satellites fly under Air Force control.

4. For example, the two world wars sparked massive production of aircraft and increases in service organizations. Additionally, the Soviet Union's development of nuclear weapons and the ensuing Cold War created new organizations to manage new capabilities. Lastly, as seen most recently, budget priorities and pressures forced reductions in the acquisition of F-22 aircraft.

5. "Public Session: Defense Business Board Quarterly Meeting, July 22, 2010," 9, <http://dbb.defense.gov/pdf/Reducing%20Overhead%20and%20Improving%20Business%20Operations.pdf>. Regarding the DOD's contractor force, Mr. Arnold Punaro notes that "it is impossible for any leadership to control costs and manage personnel if they don't know how

many people work for them. . . . The Department is as frustrated as we are since there seems to be no precise answers. Under Secretary Carter just signed-out a document that pegs the number of contractors at approximately 766,000 at a cost of about \$155 billion. This exceeds the 745,000 civil service workforce. This does not include the intelligence organizations" (ibid.).

6. "Air Force Strength from FY 1948–2012," Air Force Personnel Center, accessed 9 January 2013, [http://access.afpc.af.mil/vbinDMZ/broker.exe?\\_program=DEMOGPUB.static\\_reports.sas&\\_service=pZ1pub1&\\_debug=0](http://access.afpc.af.mil/vbinDMZ/broker.exe?_program=DEMOGPUB.static_reports.sas&_service=pZ1pub1&_debug=0); and "DoD Employment by Organization and Function" [see FY 2002–FY 2009] and "DoD Civilian Strength—Fiscal Years 1950–2001" [see table], accessed 31 January 2011, <http://siadapp.dmdc.osd.mil/personnel/CIVILIAN/CIVTOP.HTM>.

7. In view of the large number of contractor-to-civilian-personnel conversions, the 2012 projected total is more than 185,000 civilians. Therefore, all of the following calculations could indicate an even greater impact on the organization. Air Force Association, "USAF Almanac, 2011," May 2012.

8. Air Force Association, "USAF Almanac, 1980," May 1980; "2010 USAF Almanac"; and "Air Force Strength from FY 1948–2012."

9. Max Weber, *On Charisma and Institution Building* (Chicago: University of Chicago Press, 1968), 67.

10. Because the Air Force's civilian total for 2012 is expected to pass 185,000, the civilian ratio will increase to an all-time high. "USAF Almanac, 2011." The main drivers for civilian end-strength increases are contractor-to-civilian conversions; joint basing; acquisition excellence; intelligence, surveillance, and reconnaissance; fitness assessment cells; and war-fighter and family services.

11. A documented RAND briefing suggests that NAFs do not have adequate manpower to manage future conflicts. Lawrence M. Hanser, Maren Leed, and C. Robert Roll Jr., *The War-fighting Capacity of Air Combat Command's Numbered Air Forces*, documented briefing ([Santa Monica, CA:] RAND, 1998), viii, [http://www.rand.org/content/dam/rand/pubs/documented\\_briefings/2005/RAND\\_DB297.pdf](http://www.rand.org/content/dam/rand/pubs/documented_briefings/2005/RAND_DB297.pdf). In the spring of 2009, the Air Force Personnel Center filled only 75 of 1,450 rated, active duty officer staff positions—a vivid sign of manning disparity. Briefing, subject: AFPC "Road Show," Nellis AFB, NV, November 2008, slide 12.

12. Below the wing, the hierarchy continues down to the group, and then the squadron, and lastly the flight.

13. MAJCOM examples include AFMC with 11 centers as opposed to Air Force Special Operations Command with one NAF. For NAF examples, Eighteenth Air Force has 14 wings, and First Air Force has no wings.

14. Lyndall F. Urwick, "The Manager's Span of Control," *Harvard Business Review* 34 (May–June 1956): 47.

15. Air Force active duty personnel numbered just over 900,000 in 1968 and stood at 465,000 in 1992, 24 years later. Air Force Personnel Center, "Air Force Strength from 1948 thru 2010."

16. Alfred Goldberg, ed., *A History of the United States Air Force, 1907–1957* (Princeton, NJ: Van Nostrand, [1957]), 49.

17. David Mitchell, *Control without Bureaucracy* (London: McGraw-Hill, 1979), 54.

18. Ibid., 65.

19. Ibid., 72.
20. Generically, the term *rice bowls* refers to coveted or internally protected departments, projects, and so forth.
21. Samuel P. Huntington, *The Soldier and the State: The Theory and Politics of Civil-Military Relations* (Cambridge, MA: Belknap Press of Harvard University Press, 1957), 67.
22. Max Weber, *The Theory of Social and Economic Organization*, trans. A. M. Henderson and Talcott Parsons, ed. Talcott Parsons (New York: Free Press, 1947), 340.
23. Maj William C. Thomas, "The Cultural Identity of the United States Air Force," *Chronicles Online Journal*, 30 January 2004, <http://www.airpower.au.af.mil/airchronicles/cc/thomas.html>.
24. Gen Norman Schwartz, former Air Force chief of staff, defined the LRS capability in a speech at an Air Force Association conference in 2010: "An Air Force core contribution that combines multiple systems to provide the Nation with the capability to overcome area-denial measures, penetrate contested airspace and networks, and assure freedom of action to deliver air, space, and cyber power effects." Gen Norton Schwartz (keynote speech, Air and Space Conference, Air Force Association, 14 September 2010), 11, <http://www.af.mil/shared/media/document/AFD-100914-056.pdf>.
25. For an excellent summary of ACC's efforts to pursue a bomber study while AFSPC conducts a similar analysis on its conventional intercontinental missile system, known as Prompt Global Strike, see Marc Selinger, "USAF Eyes Study on Long-Range Strike," *Aviation Week*, 3 October 2005.
26. Department of the Air Force, *The U.S. Air Force Transformation Flight Plan 2004* (Washington, DC: Deputy Chief of Staff for Plans and Programs, Department of the Air Force, 2004), 37, <http://www.dtic.mil/cgi-bin/GetTRDoc?AD=ADA440807&Location=U2&doc=GetTRDoc.pdf>.
27. Department of the Air Force, *2008 Air Force Strategic Plan* (Washington, DC: Department of the Air Force, October 2008), 8, 9, <http://cpc.au.af.mil/PDF/2008%20Air%20Force%20Strategic%20Plan,%20Oct%202008.pdf>.
28. Department of the Air Force, *Organizational Threshold Review Memorandum*, 17 August 2009, includes guidelines for a wing, group, and squadron, requiring a minimum threshold of 1,000, 400, and 35 Airmen, respectively. Units not meeting these minimums had to dissolve, often transitioning to a lower echelon or merging with other units to meet the threshold.
29. Air Force News Service, "Efficiencies, Balance Main Focuses of FY12 Budget," 14 February 2011, <http://www.af.mil/news/story.asp?id=123242539>. Since further details were not yet available for consideration, they will not factor into the reorganization proposal.
30. Air Force Instruction 38-101, *Air Force Organization*, 16 March 2011, 6, <http://www.e-publishing.af.mil/shared/media/epubs/AFI38-101.pdf>.
31. Secretary of Defense, *Unified Command Plan—06 April 2011* (Washington, DC: Secretary of Defense, 12 September 2011), 2.
32. Carl H. Builder and Theodore W. Karasik, *Organizing, Training, and Equipping the Air Force for Crises and Lesser Conflicts* (Santa Monica, CA: RAND, 1995), 29, [http://www.rand.org/content/dam/rand/pubs/monograph\\_reports/2006/MR626.pdf](http://www.rand.org/content/dam/rand/pubs/monograph_reports/2006/MR626.pdf).
33. Air Force Doctrine Document 2, *Operations and Organization*, 3 April 2007, ix, <http://www.e-publishing.af.mil/shared/media/epubs/afdd2.pdf>.

34. Department of Defense, *Quadrennial Defense Review Report* (Washington, DC: Department of Defense, February 2010), 18, <http://www.defense.gov/qdr/qdr%20as%20of%2026jan10%200700.pdf>.

35. "Strengthening international and regional security requires that our forces be globally-available, yet regionally-focused." Joint Chiefs of Staff, *The National Military Strategy of the United States of America* (Washington, DC: Joint Chiefs of Staff, 2011), 10, <https://acc.dau.mil/adl/en-US/425505/file/55897/2011%20National%20Military%20Strategy.pdf>.

"Build the security capacity of partner states. . . . Building the capacity of our partners to deter and prevent conflict makes them more capable of providing assistance as we address common threats together." Department of Defense, *Quadrennial Defense Review Report*, 2, 104. The *National Security Strategy* identifies one of the key strategic approaches: "An international order advanced by U.S. leadership that promotes peace, security, and opportunity through stronger cooperation to meet global challenges." President of the United States, *National Security Strategy* (Washington, DC: White House, May 2010), 7, [http://www.whitehouse.gov/sites/default/files/rss\\_viewer/national\\_security\\_strategy.pdf](http://www.whitehouse.gov/sites/default/files/rss_viewer/national_security_strategy.pdf).

36. Joint Chiefs of Staff, *National Military Strategy*, 15.



### Col Jeffrey P. Sundberg, USAF

Colonel Sundberg (BS, University of Colorado; MS, Naval Postgraduate School; MS, Army Command and General Staff College; MBA, University of Phoenix) serves at Headquarters North American Aerospace Defense Command–US Northern Command, Peterson AFB, Colorado. Previously, he served as an air defense aggressor squadron commander, an instructor at various assignments, and at Headquarters Air Force. A career air battle manager, he has more than 1,800 hours in the E-3 Airborne Warning and Control System. Lieutenant Colonel Sundberg is a graduate of the USAF Weapons School, Naval Postgraduate School, and the School of Advanced Military Studies' Advanced Operational Art Studies Fellowship program.

**Let us know what you think! Leave a comment!**

**Distribution A: Approved for public release; distribution unlimited.**

#### Disclaimer

The views and opinions expressed or implied in the *Journal* are those of the authors and should not be construed as carrying the official sanction of the Department of Defense, Air Force, Air Education and Training Command, Air University, or other agencies or departments of the US government.

This article may be reproduced in whole or in part without permission. If it is reproduced, the *Air and Space Power Journal* requests a courtesy line.

<http://www.airpower.au.af.mil>